

AXOR



AXOR FinishPlus Stocked Collections

From personalities for personalities

Why

FIVE REASONS TO CHOOSE AXOR

01 Design diversity

AXOR collaborates with internationally renowned designers. With their highly distinct signatures, they shape the great stylistic diversity and product depth of the AXOR range. Their design approaches set standards again and again – in terms of their avant-garde designs, which are innovative and timeless at the same time. As part of AXOR WaterDreams, designers from completely different disciplines create their vision of the bathroom of the future, completely detached from a product-oriented development. With their ideas, they provide new inspiration for the development of the space, its use, and matching products.

In the following collections, unique water designs create extraordinary haptic and visual experiences – with innovative spray modes and a completely new way of presenting water:

- AXOR Massaud with a natural looking waterfall
- AXOR Starck Organic with the gentle shower spray on a mixer for the first time
- AXOR Starck V with powerful water vortex
- AXOR MyEdition with PowderRain – a stage for self expression



02 Individualisation

The exclusive AXOR FinishPlus and AXOR Signature customisation services meet customers' increasing demand for more options to customise bathroom products. With colored PVD surfaces and customised solutions, AXOR products become unmistakably unique.

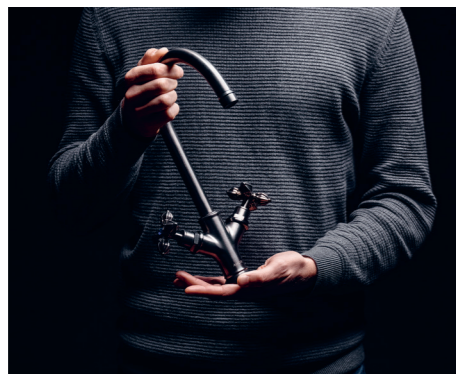

03 Made in Germany

At AXOR's own factory at its headquarters in Schiltach, Germany, the first-class brand products are created with German engineering quality and a deep commitment to precision – in every detail. This know-how builds on the Hansgrohe Group's more than 120 years of experience, as well as the expertise of every single skilled worker. AXOR is also a pioneer in innovative manufacturing technologies, such as the latest generation diamond drilling machine for ultra-precision milling of surfaces in the AXOR Edge collection.



04 Worldwide presence

As part of the Hansgrohe Group, AXOR has 32 subsidiaries and 22 sales offices worldwide and supplies its products to over 146 countries. AXOR basin mixers, showers, and kitchen mixers can be found in the world's finest homes, hotels, and restaurants. International architects, planners, and builders trust AXOR quality in products and expert advice.

05 International design awards

AXOR's design achievements – marked by independent, internationally renowned industry experts – are confirmed by the numerous awards the brand has received for first-class product design since the very beginning. These include:

- Red Dot Best of Best for AXOR Edge
- German Design Award for AXOR MyEdition
- iF Design Award in Gold for AXOR One, AXOR Uno and AXOR ShowerComposition
- Green Design Award for AXOR Starck Organic

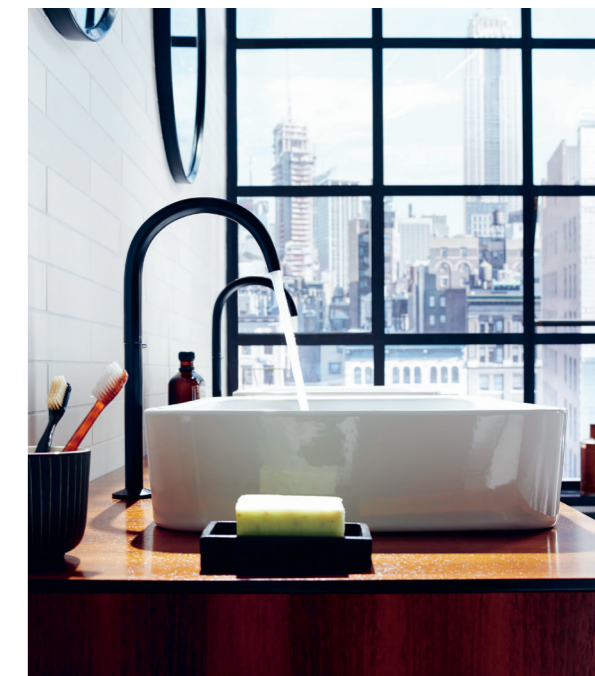

AXOR FinishPlus

The refinement of the unique

The exclusive surface finishes from AXOR FinishPlus set new standards, from the new, lacquered Matt Black surface to Polished Gold Optic and Brushed Black Chrome.

Surfaces of exceptional brilliance, robustness, and durability, manufactured in Germany to the highest technical standards – from single pieces to large quantities.



AXOR FinishPlus PVD surface finishes have character. Each colour is the result of intensive development and refined in AXOR's vacuum chambers using the PVD (physical vapor deposition) process.

An electric arc discharges in the high vacuum, gases combine with zirconium. The mixture hits the mixer's chrome surface. This high-tech process gives the surface unprecedented brilliance and high resistance to scratches, cleaning agents, and the salt of the sea air.

Place your order and receive the complete AXOR FinishPlus Bathroom Solution

within 2 weeks



- / AXOR FinishPlus meets the increasing desire for individualisation: The surfaces can be made to match the interior design perfectly.
- / A standardised process guarantees consistent quality
- / The AXOR FinishPlus surface finishes, developed by our own experts through intensive research work, underline the role of AXOR as an innovative leader in the area of surfaces
- / A mixer with an AXOR FinishPlus surface, along with its spare parts, is available for purchase in an identical quality and design for 15 years
- / In addition to the prespecified AXOR FinishPlus surfaces, other surfaces can be produced according to personal specifications by request through AXOR Signature

AXOR Ranges are now stocked in up to 6 PVD finishes

Receive your AXOR products

Coloured surface finishes for design bathrooms.

Over 1000 article numbers in PVD, over 18 ranges are now in stock.

Article numbers that are now stocked are indicated in the product price book 2023.

within 2 weeks of ordering

A rich colour palette for interior design.

AXOR FinishPlus surfaces offer exceptional robustness, durability and scratch-resistance, all while setting the standard for colour depth and reflective brilliance. Produced in AXOR's state-of-the-art PVD (physical vapor deposition) chambers, the surfaces are hand-finished by expert technicians. Brushed or polished until immaculately smooth, they offer the perfect finishing touch to any luxury bathroom. The result of exhaustive research and development, AXOR FinishPlus is a reflection of AXOR's commitment to provide the ultimate in individualisation.

AXOR Stocked Matrix

Collection overview and combination options

SCAN FOR ARTICLE NUMBERS



	Chrome	Matt Black	Matt White	Brushed Black Chrome	Brushed Nickel	Brushed Bronze	Brushed Steel Optic	Polished Gold Optic	Polished Red Gold	Polished Black Chrome	Brushed Gold Optic	Brushed Red Gold	Brushed Brass
	000	670	700	340	820	140	800	990	300	330	250	310	950
AXOR One	●	●	●	●	◇	●	◇	●	◇	◇	◇	◇	◇
AXOR Starck	●	x	x	●	◇	◇	◇	◇	◇	◇	◇	◇	◇
AXOR Starck Organic	●	x	x	◇	◇	◇	◇	◇	◇	◇	◇	◇	◇
AXOR Citterio	●	x	x	●	◇	◇	◇	◇	◇	◇	◇	◇	◇
AXOR Citterio E	●	●	x	●	◇	●	◇	◇	◇	◇	◇	◇	◇
AXOR Citterio M	●	x	x	◇	◇	◇	◇	◇	◇	◇	◇	◇	◇
AXOR MyEdition	●	●	x	●	◇	●	◇	◇	◇	◇	◇	◇	◇
AXOR Urquiola	●	x	x	◇	◇	◇	◇	◇	◇	◇	◇	◇	◇
AXOR Massaud	●	x	x	◇	◇	◇	◇	◇	◇	◇	◇	◇	◇
AXOR Edge	●	x	x	x	x	x	x	◇	◇	◇	x	x	x
AXOR Uno	●	x	x	●	●	◇	◇	◇	◇	◇	◇	◇	◇
AXOR Montreux	●	x	x	●	●	◇	◇	◇	◇	◇	◇	◇	◇
AXOR Showers*	●	●	●	●	●	●	◇	●	◇	◇	◇	◇	◇
AXOR Universal Accessories	●	●	●	●	●	●	◇	●	◇	◇	◇	◇	◇
AXOR ShowerComposition	●	●	◇	◇	◇	◇	◇	◇	◇	◇	◇	◇	◇
AXOR Kitchen mixers*	●	●	x	●	◇	◇	●	◇	◇	◇	◇	◇	◇
AXOR Suite Basins & Bathtub	●	●	x	●	◇	●	◇	◇	◇	◇	◇	◇	◇
AXOR Drain	●	●	●	●	◇	●	●	●	◇	◇	◇	◇	◇

Delivery time: ● In Stock ◇ 8 weeks x Not available to order

All products detailed are 'in stock' in Germany and will take 2 weeks from order to be delivered to the UK.

12	AXOR One	60	AXOR ShowerComposition
18	AXOR Citterio	64	AXOR Showers
26	AXOR Citterio E	74	AXOR Suite Basins & Bathtub
32	AXOR Starck	78	AXOR Drain
38	AXOR Starck V	82	AXOR Accessories
42	AXOR Uno	92	AXOR Kitchen
48	AXOR MyEdition		
54	AXOR Montreux		

12



48



32

38



42



18



The Essence



of Simplicity

A collection of sleek, elegant shapes



AXOR One

DESIGN
—
BARBER OSGERBY

Monolithic design for the shower

The AXOR One overhead showers and hand showers feature monolithic forms and an innovative organisation of Rain and PowderRain spray types, reflected in the distinctive graphic language of the showerhead's spray disc. The AXOR One showerpipe is the perfect all-in-one combination of overhead shower, hand shower, wall bar and wall outlet. The showerpipe and shower set offer a clean appearance thanks to their integrated wall outlet. The entire collection can be personalised in Matt Black or an exclusive AXOR FinishPlus surface.

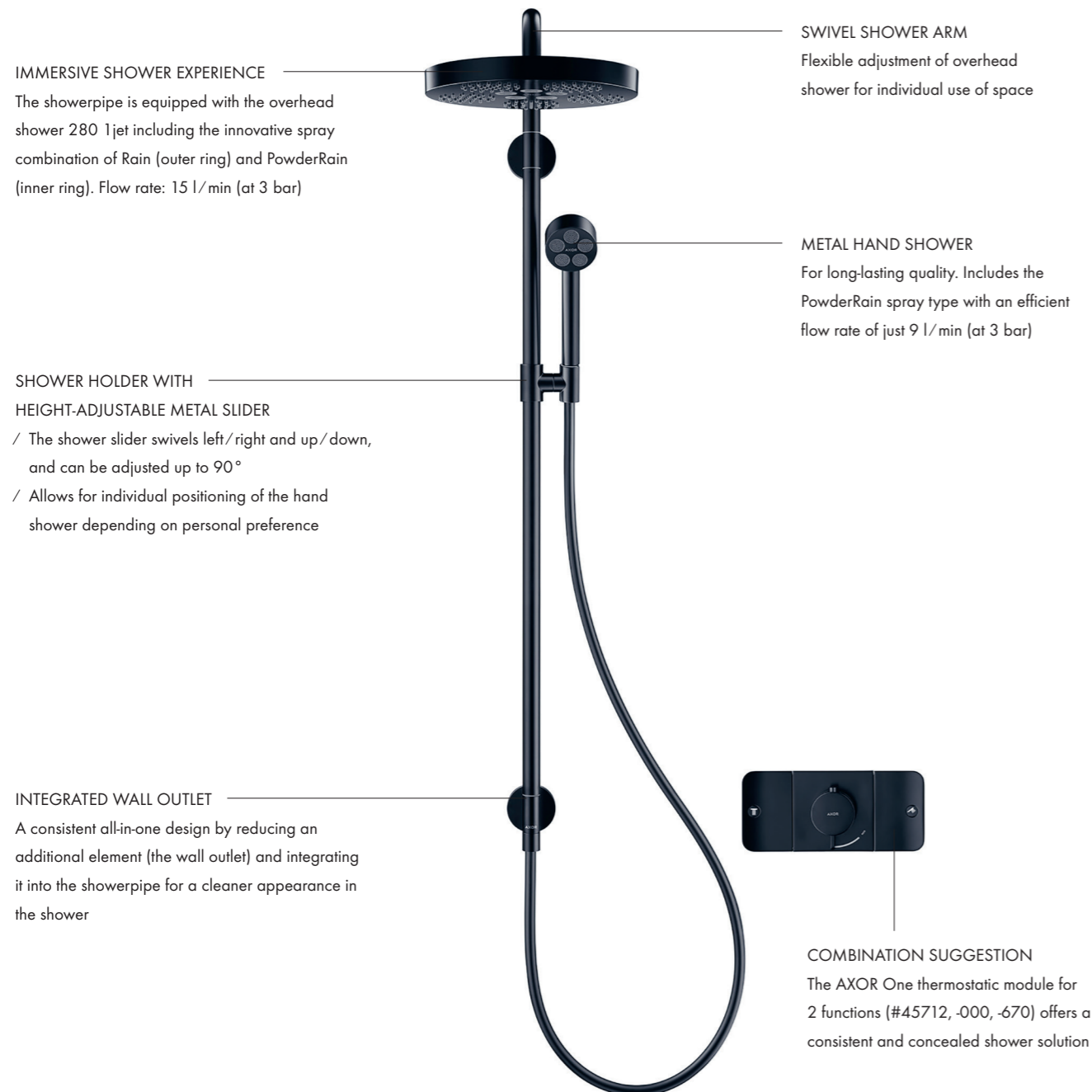

The essence of simplicity with new interaction

A collection of elegant archetypes for the wash basin, bathtub and shower, AXOR One is unified by a holistic design language of slender silhouettes, flat surfaces, soft corners and balanced proportions. The iconic mixers feature a gentle taper to their curved spouts, a subtle detail that signals exceptional quality of design and manufacturing. Utilising Select technology, the mechanical mixer handles enable precise, water-saving on/off and temperature control.



ON/OFF:
Press down on its all-in-one controller - the Select handle - to start or stop the water.

TEMPERATURE CONTROL:
Swivel clockwise to increase the temperature. The handle includes a preset CoolStart function, an environmentally friendly technology that helps conserve resources.



A new mode of interaction.

AXOR One is characterised by a holistic design language of slender silhouettes, flat surfaces, soft corners and balanced proportions. At the washbasin, the archetypal parabolic mixer with all-in-one controller features a gentle taper to the curved spout, a subtle detail that signals exceptional quality of design and manufacture. Utilising Select technology, the mechanical controller provides a new mode of interaction. Simply press down to start or stop the water; swivel clockwise to increase the temperature. Easy, intuitive and precise, the new interaction mode also conserves water.

Excellence in the shower.

The AXOR One collection includes a wide range of options for a personalised shower experience. The showerpipe is an all-in-one combination of overhead shower, hand shower and wall bar that offers a clean appearance thanks to the integrated wall outlet. The overhead showers and hand showers feature monolithic forms and an innovative organisation of Rain and PowderRain spray types, reflected in the distinctive graphic language of the spray disc. The AXOR One thermostatic module uses large, clearly marked, highly responsive paddle handles to offer intuitive control of spray types and ultra-precise control of water temperature and volume.



Archetypal beauty beside the bath.

With AXOR One, Edward Barber and Jay Osgerby have reinvented familiar archetypes - for greater clarity of form, improved function, and optimal control. The result is a collection of sleek, elegant shapes that embody the principles of compact luxury.

Available within 2 weeks
AXOR One is stocked in 6 finishes

AXOR ONE STOCKED FINISHES
ARE AVAILABLE IN :



MATT
BLACK
- 670



MATT
WHITE
- 700



BRUSHED BLACK
CHROME
- 340



BRUSHED
BRONZE
- 140



POLISHED
GOLD OPTIC
- 990



CHROME
- 000

AXOR One

The essence of simplicity

A bathroom collection so elegant, elemental and pure, it could be realised only through radical innovation.

At the wash basin, bathtub or shower you will experience greater clarity, enhanced function and superior control.

The collection brings timeless design to any bathroom.

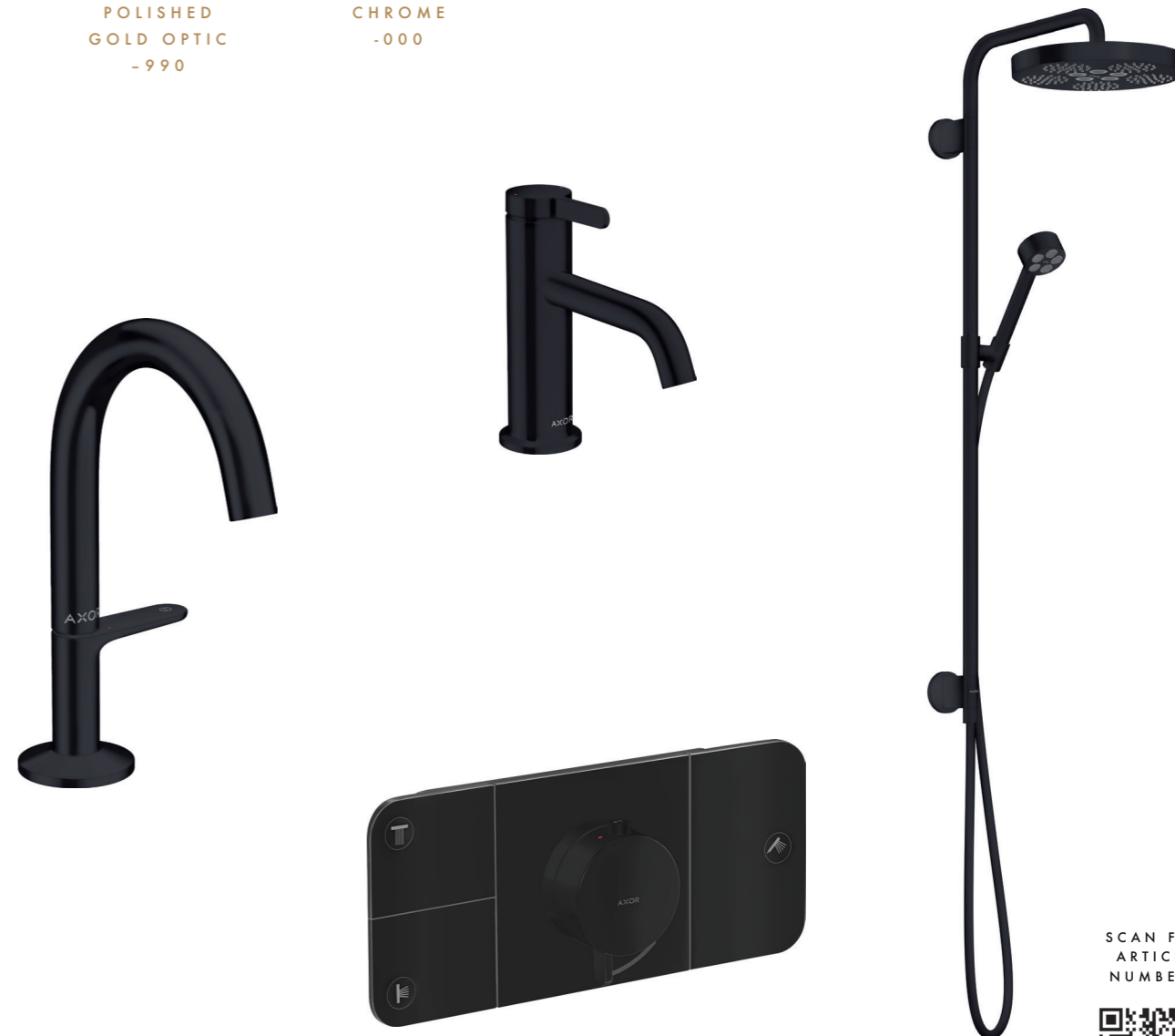

SCAN FOR
ARTICLE
NUMBERS





The contemporary classic.



AXOR Citterio

DESIGN
—
ANTONIO CITTERIO

Water is precious. AXOR Citterio, a striking collection that is tangibly and visibly high-quality, is the best way to celebrate water. Strong shapes, soft lines, and striking surfaces, combined in a unique geometric harmony, reveal the characteristic influences of Italian neoclassical architecture. A modern classic – unmistakably contemporary, unforgettably timeless.

Striking design in the shower

The exposed shower system provides superior showering comfort. It offers total flexibility with regard to installation and is especially suitable for renovations. It's easy to adjust the spray angle of the overhead shower which is equipped with the Rain spray mode. The integrated thermostatic mixer technology saves water and can be used to set the desired shower temperature precisely. The SafetyStop function prevents scalding.

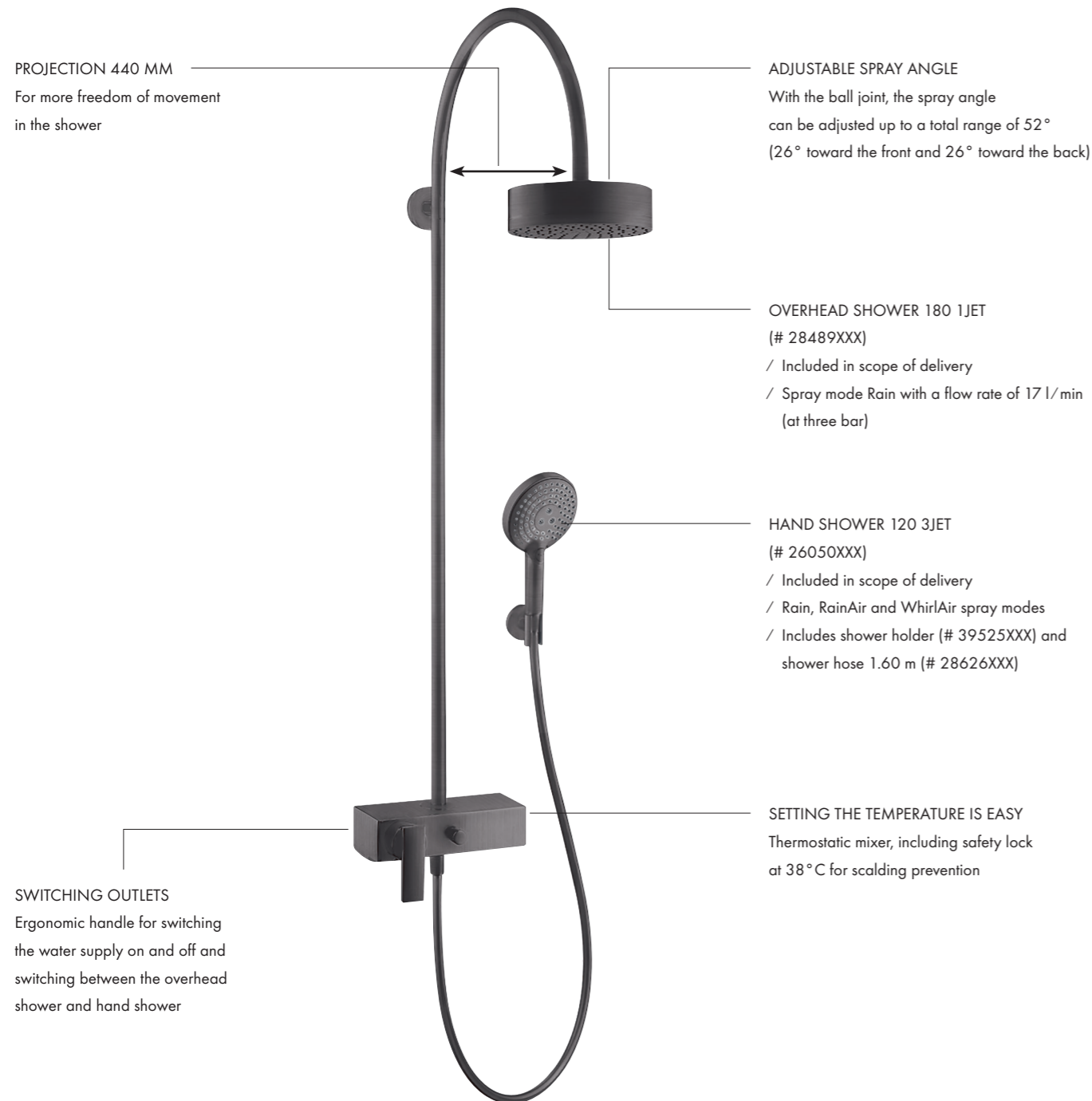

A monument at the wash basin

The AXOR Citterio collection offers a variety of product variants: pin, cross and lever handles as well as products with cover plates and escutcheons. Various installation types and diverse spout lengths and mixer heights cover nearly every installation situation. In its geometric precision and monumentality, AXOR Citterio conveys the spirit of Italian neoclassical architecture. The comprehensive product range for wash basin, shower and bathtub enables endless individual solutions, all within a consistent design language.

LEVER HANDLE WITH SURFACE PATTERN

The 'rhombic cut' is a haptic and optical experience and exclusively available for the new lever handle

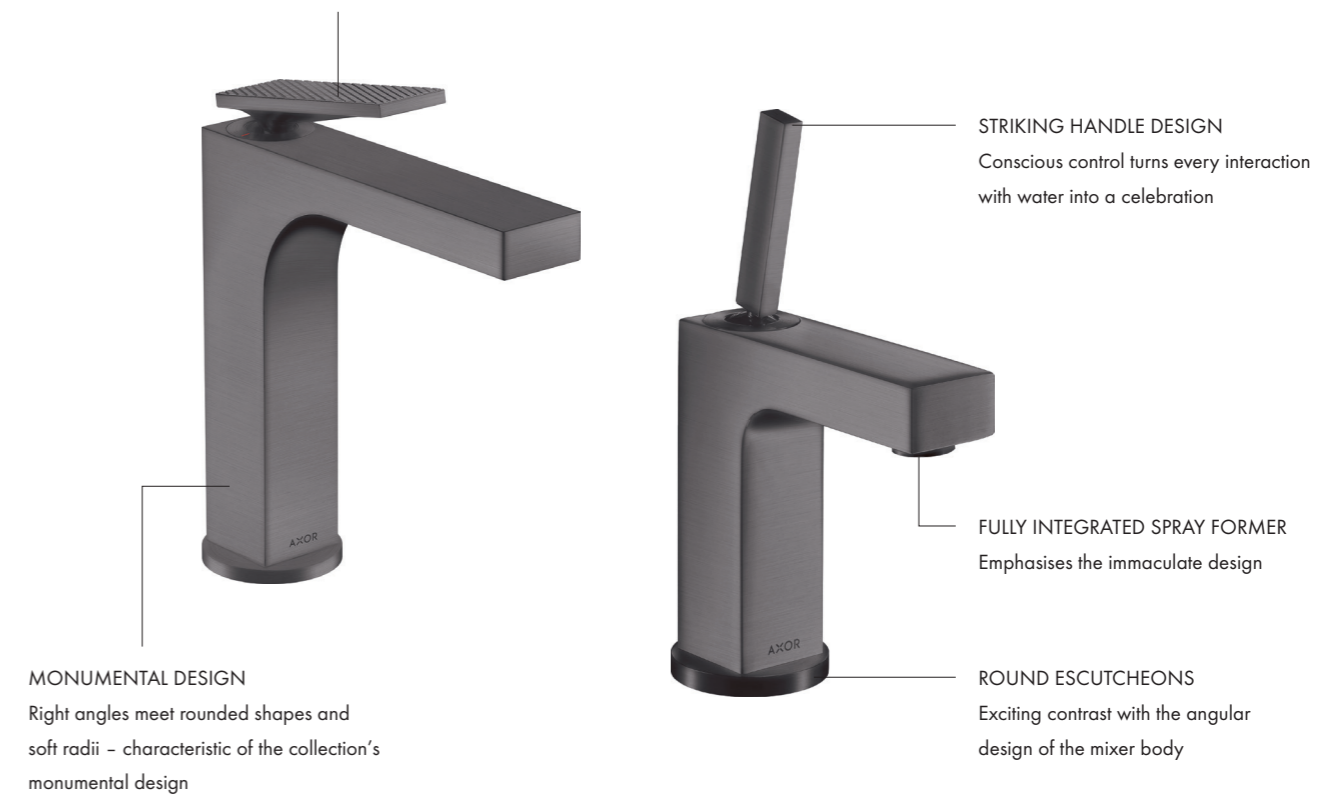

Striking pin handle:

- / Iconic handle with modern, technological enhanced joystick cartridge
- / The striking design creates a deeper awareness and appreciation of water

Lever handle:

- / 'Floating' form continues the architectonic design language
- / Even more ergonomic, intuitive and easy to use
- / Offers precise control of water temperature and volume
- / Optional available with exclusive 'rhombic cut'

Classic cross handles:

- / Timeless design, proven functionality and familiar mechanical operation
- / The classic air of the three-hole mixer version and offer direct and separate control of hot and cold water
- / Available with escutcheons or plate



A range of mixers for all washbasins.

At the washbasin, AXOR Citterio comprises a wide range of mixer types and handle styles. Along with the pin handle, cross handle and original lever handle, the collection now includes a 'floating' lever handle that is even more precise, intuitive and easy to use. Those who enjoy celebrating the daily ritual of washing should do so with beautiful objects.

Precision in the shower.

Bring the neoclassical design language of AXOR Citterio into the shower with a range of elegant solutions, including the showerpipe with single-lever handle and overhead shower. Easy to adjust and to personalise, the showerpipe features an overhead shower equipped with relaxing RainSpray technology and an integrated thermostatic mixer that provides precise temperature control while conserving water.

The AXOR Citterio offering also includes overhead showers, baton hand showers, thermostats for exposed and concealed installation, and a range of diverter valves with lever or cross handles, hand shower with both immersive Rain and concentrated MonoRain spray types. Simply press down to start or stop the water; swivel clockwise to increase the temperature. Easy, intuitive and precise, the new interaction mode also conserves water.



A form for every bathtub.

Tall and slender, the floorstanding AXOR Citterio bathtub mixer makes a distinctive impression. Monumental in its proportions, it weds elegance of function to elegance of form.

The mixer is available with the collection's signature pin handle or the new 'floating' lever. The baton hand shower comes with both the gentle Rain and the focused MonoRain spray types. Other AXOR Citterio options at the bathtub include wall-mounted single-lever mixers with lever handles, three-hole mixers with lever or cross handles (for exposed or concealed installation), rim- or tile-mounted four-hole mixers, and a four-hole rim-mounted thermostatic mixer.

Available within 2 weeks
AXOR Citterio is stocked in 2 finishes

AXOR CITTERIO STOCKED FINISH
IS AVAILABLE IN :

BRUSHED BLACK
CHROME
- 340

CHROME
- 000

AXOR Citterio

A contemporary classic

AXOR Citterio is an icon of modern bathroom design. Understated yet unmistakably luxurious, with distinctive flat surfaces that brilliantly reflect the light, AXOR Citterio celebrates the preciousness of water itself. With its balanced proportions and elegant geometries, the collection is perfectly suited to any bathroom ambiance.



SCAN FOR
ARTICLE
NUMBERS





MASTERFUL NEOCLASSICISM

Corners, edges, and pronounced flatness. Radii that bow to the element of water. It is evocations like these that make AXOR Citterio a tribute to the neoclassicism of the 1930s. And to a monumental appearance at the wash basin that lets us experience time in a conscious manner.

A synthesis.
An evolution.



A continual
sophistication.

The essence of elegance.



AXOR Citterio E

DESIGN
—
ANTONIO CITTERIO

A perfect symbiosis of right angles and soft, round shapes

Elegance and ease of use come together in the single-hole basin mixer. Precisely worked surfaces and edges are combined with gentle shapes and escutcheons in Softsquare design. Different handle variants, such as the slim joystick handle or the lever handle, are an expression of high quality.



Cross handles, with their classic look, characterise the three-hole wash basin mixers. Ergonomic, with soft radii, they are easy to grip and to operate.

Intuitive and ergonomic operation at the bathtub



The four-hole rim-mounted mixer is a timeless, elegant product for the bathtub. At the same time, the handles offer intuitive operation: the temperature with the cylindrical handle, the water flow with the ergonomic cross handle.



The floorstanding thermostatic mixer for the bathtub is an eye-catcher. The simple baton hand shower has two spray modes, the elegant cross handle controls water flow, and the thermostatic mixer is used to set the temperature.



At the wash basin, a versatile selection of mixers.

AXOR Citterio E offers single-lever basin mixers in a range of forms and heights, with intuitive pin or lever handles. The collection also includes three-hole basin mixers, exclusively with cross handles, and wall-mounted basin mixers for concealed installation, either with one plate or with escutcheons, in both single-lever and three-hole configurations.

An array of elegant solutions for the modern bath.

AXOR Citterio E offers an array of elegant solutions for the bath. The statuesque floorstanding thermostatic mixer, shown here finished in Brushed Black Chrome, includes a baton hand shower featuring both immersive Rain and focused MonoRain sprays. The collection also includes rim- and tile-mounted thermostatic bath mixers in two-hole and four-hole configurations, wall-mounted single-lever mixers, thermostats for exposed installation and diverter valves, as well as its own distinctively shaped bath spout.



Visual and sensory pleasure in the shower.

The collection's wide range of options for the shower includes thermostats for exposed installation, shower bars, diverter valves, and shower sets with hand showers offering three spray types. All are combinable with a variety of AXOR overhead showers and with the AXOR Universal Accessories range, created in collaboration with Antonio Citterio.

Available within 2 weeks
AXOR Citterio E is stocked in 4 finishes

AXOR CITTERIO E STOCKED FINISHES
ARE AVAILABLE IN :



MATT
BLACK
- 670



BRUSHED
BRONZE
- 140



BRUSHED BLACK
CHROME
- 340



CHROME
- 000

AXOR Citterio E

The essence of elegance

AXOR Citterio E perfects the beauty of proportionality and connects curved and angular shapes, familiar and new, classic and modern, to create a timeless elegant form. Balanced right down to the last detail.



SCAN FOR
ARTICLE
NUMBERS





Design Visionary

“The only acceptable style is freedom.”



AXOR Starck

DESIGN
—
PHILIPPE STARCK

A luxurious shower experience for indoors and outdoors with the AXOR Starck shower column

The minimalist in the shower. Uncompromisingly streamlined, the shapes come together to form a unique whole: a circle. A cylinder. A rod. The result is a one-of-a-kind shower column – now also for outdoor use.

AXOR OVERHEAD SHOWER 240 1JET
 / High-quality metal disc with generous diameter (240 mm)
 / Enveloping PowderRain spray
 / With user-friendly QuickClean cleaning function

/ Indoor version: Thermostat with scalding protection at 40°C
 / Outdoor version: MR32 mixing cartridge for temperature control

/ Switching between overhead and hand showers and integrated volume control

AXOR BATON HAND SHOWER 2JET
 / A classic in design and function. The baton hand shower sets the precedent for innovative control: simple rotation allows users to switch between the soft Rain spray and the powerful Mono spray
 / Positioned in a high-quality metal holder

/ Indoor version: Basic set (#10902XXX) for the shower column positioned behind the wall flange
 / Outdoor version: Adapter set for quick and easy installation and removal, as well as for fast draining to keep from freezing in the winter – included in delivery

/ The shower column pipe makes it seem as if the water is coming directly out of the floor

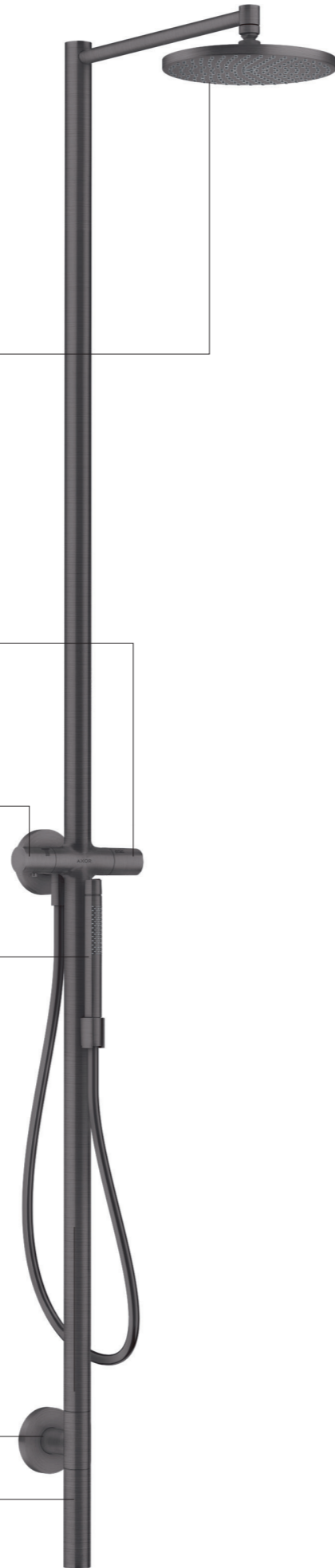

The beauty in simplicity

The collection that revolutionised bathroom design. Its archetypal form, inspired by the traditional well pump, tells a story of beauty in simplicity. By reducing the mixer to pure essence, just two pipes and a joystick control, it focuses our attention on water itself. A collection as relevant today as it was at its launch more than 25 years ago.



AXOR STARCK SINGLE LEVER WASH BASIN MIXER WITH PIN HANDLE
 / Pin handle with integrated joystick cartridge: The sophisticated handle completes the minimalist design
 / Integrated cartridge enables a slim body
 / Three simple cylinders engender the minimalist design
 / Available in four heights: 70, 90, 170, 250

AXOR STARCK SINGLE LEVER WASH BASIN MIXER WITH LEVER HANDLE
 / Lever handle: The ergonomic lever handle represents modern minimalism
 / Available in three heights: 80, 100, 250
 / A CoolStart variant for saving energy and water is available





At the bathtub. Relaxation on tap.

Reimagining the humble well pump for the modern bathroom, AXOR Starck cloaks ultra-sophisticated technology in a design of pure simplicity. The archetypal mixer is available for the bath as a single-lever for exposed or concealed installation, as well as in two-handle and four-hole bath-mounted versions. An iconic presence in any luxury bathroom, the AXOR Starck floorstanding mixer is especially suited to standalone bathtubs. From above, the AXOR Starck generously sized showerplate uses RainAir technology to cocoon the user in superfine droplets.

In the shower, a celebration of water.

Radically minimalist in design, the AXOR Starck shower column focuses the attention on water itself. Exposed or concealed, the thermostatic mixer provides precise regulation of water temperature and flow volume. Available with a single spray as standard, AXOR Starck also offers a dual spray hand shower with both immersive Rain and concentrated MonoRain spray types. Simply press down to start or stop the water; swivel clockwise to increase the temperature. Easy, intuitive and precise, the new interaction mode also conserves water.



Hands-free at the wash basin: The AXOR Starck electronic mixer.

Groundbreaking at its introduction, the AXOR Starck collection continues to set new benchmarks for innovation and ingenuity. Today, at the wash basin, the electronic mixer features infrared sensors for ultra-precise operation and economical water consumption, all without so much as the touch of a button.

Available within 2 weeks
AXOR Starck is stocked in 2 finishes

AXOR STARCK STOCKED FINISH
IS AVAILABLE IN :

BRUSHED BLACK
CHROME
- 340

CHROME
- 000

AXOR Starck

Minimalist bathroom design

AXOR Starck embodies the aesthetic of minimalism. The design focuses on the essential. A familiar shape, uncompromising in function, with an elemental connection to water. And therefore, an archetype: The collection is inspired by the historic hand pump used to pump water from wells.



SCAN FOR
ARTICLE
NUMBERS



The of Vitality Water

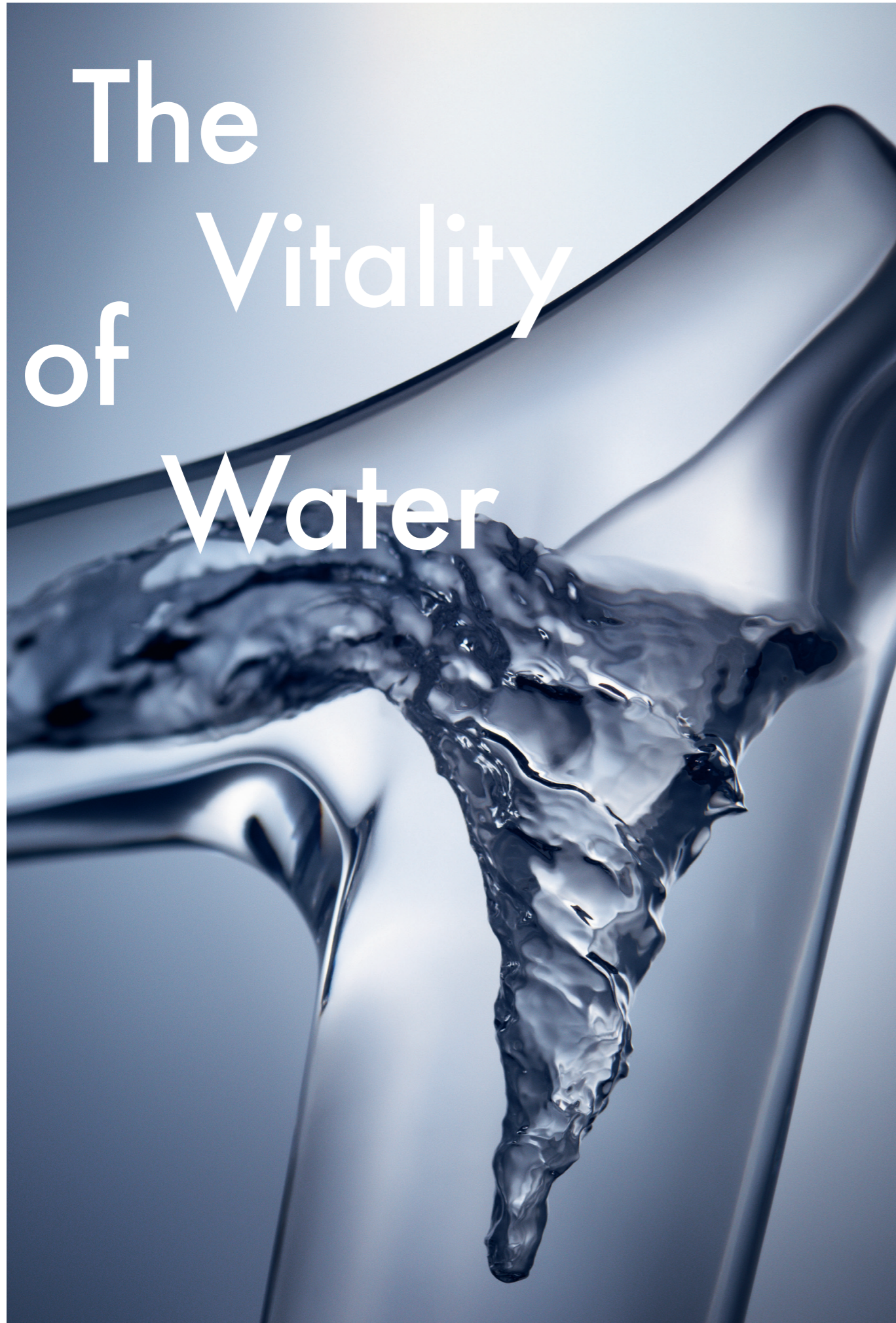

"The miracle of water."



AXOR Starck V

DESIGN
—
PHILIPPE STARCK

FACETS OF EXTRAVAGANCE

The crystal glass spout, classically elegant or refined as a diamond cut or faceted, can be changed with a click.



A sculpture in crystal glass or frosted porcelain.

Sculpted from flawless crystal glass or translucent frosted porcelain, the AXOR Starck V mixer body swivels 360° to enable optimal, splash-free orientation of its open spout. An integrated SafetyStop mechanism ensures no water is wasted when the mixer body detaches – with one easy click – from its metallic base for deep cleaning by hand or dishwasher. Simply press down to start or stop the water; swivel clockwise to increase the temperature. Easy, intuitive and precise, the new interaction mode also conserves water.

Diamond-cut and bevel-cut variants play with light.

Fashioned from ecologically sourced materials, AXOR Starck V can serve as the statuesque centrepiece of any luxury bathroom. For an extra touch of magical opulence, diamond-cut and bevel-cut variants feature intricate geometric adornment at the mixer base. These special cuts capture the light in extravagant refractive patterns, enhancing the spellbinding effect of the vortex itself.

AXOR innovation results in a captivating breakthrough.

AXOR Starck V's spiraling vortex is formed by a specially developed jet shaper, custom-designed to release an ideal degree of centrifugal force. The strength of the vortex is easily adjusted using a simple hex key included with delivery. More than a mixer, AXOR Starck V is a sculpture, a fountain, a functioning objet d'art, conceived to cultivate renewed awareness and appreciation of the everyday miracle of clean water.



Available within 2 weeks
AXOR Starck V is stocked in 2 finishes

AXOR STARCK V STOCKED FINISH IS AVAILABLE IN :

POLISHED
GOLD OPTIC
- 990

CHROME
- 000

AXOR Starck V

The vitality of water

AXOR Starck V is a unique eye-catcher at the wash basin. With its organic, sculptural design, the spectacular glass body displays the water, revealing a wonder of nature: the water vortex. In all its strength and beauty. Vital and captivating.



“AXOR STARCK V IS A REVOLUTION: A MINIMAL OBJECT, NEARLY INVISIBLE AND TOTALLY TRANSPARENT, THAT ENCLOSES THE WATER VORTEX. THIS ENABLES A SPECIAL EXPERIENCE WITH WATER.”

Philippe Starck

SCAN FOR
ARTICLE
NUMBERS





AXOR Uno

With essential shapes and visible constructions, AXOR Uno is purism perfected. The mixer consists of apparently simply connected pipes, the most traditional method for transporting water. Subtly adhering to the golden ratio, the aesthetic form unfolds a special power: the power of purism.

Minimalist look for the bathtub

An icon for your bathtub: Clear, linear forms with a diagonal spout that recalls the historical hand pump. The floorstanding bathtub mixer is particularly suitable for free-standing bathtubs.



VARIOUS HANDLE VARIANTS
/ Available with various handle variants to match the selected wash basin mixer

SWITCHING OUTLETS
/ Switching from bathtub mixer to hand shower is done at the bath spout
/ Flow rate: 22 l/min (at 3 bar)

METAL EFFECT SHOWER HOSE 1.25 M (# 28282XXX) AND BATON HAND SHOWER 2JET (# 28532XXX)
/ Included in scope of delivery

Perfect purism in shower design

The AXOR Showerpipe 800 provides an integrated system solution, consisting of a thermostatic mixer, overhead shower and hand shower, all in the purist pipework design of the AXOR Uno collection. Select technology makes the Showerpipe with its integrated AXOR overhead shower 350 1jet and innovative PowderRain spray mode easy to operate.

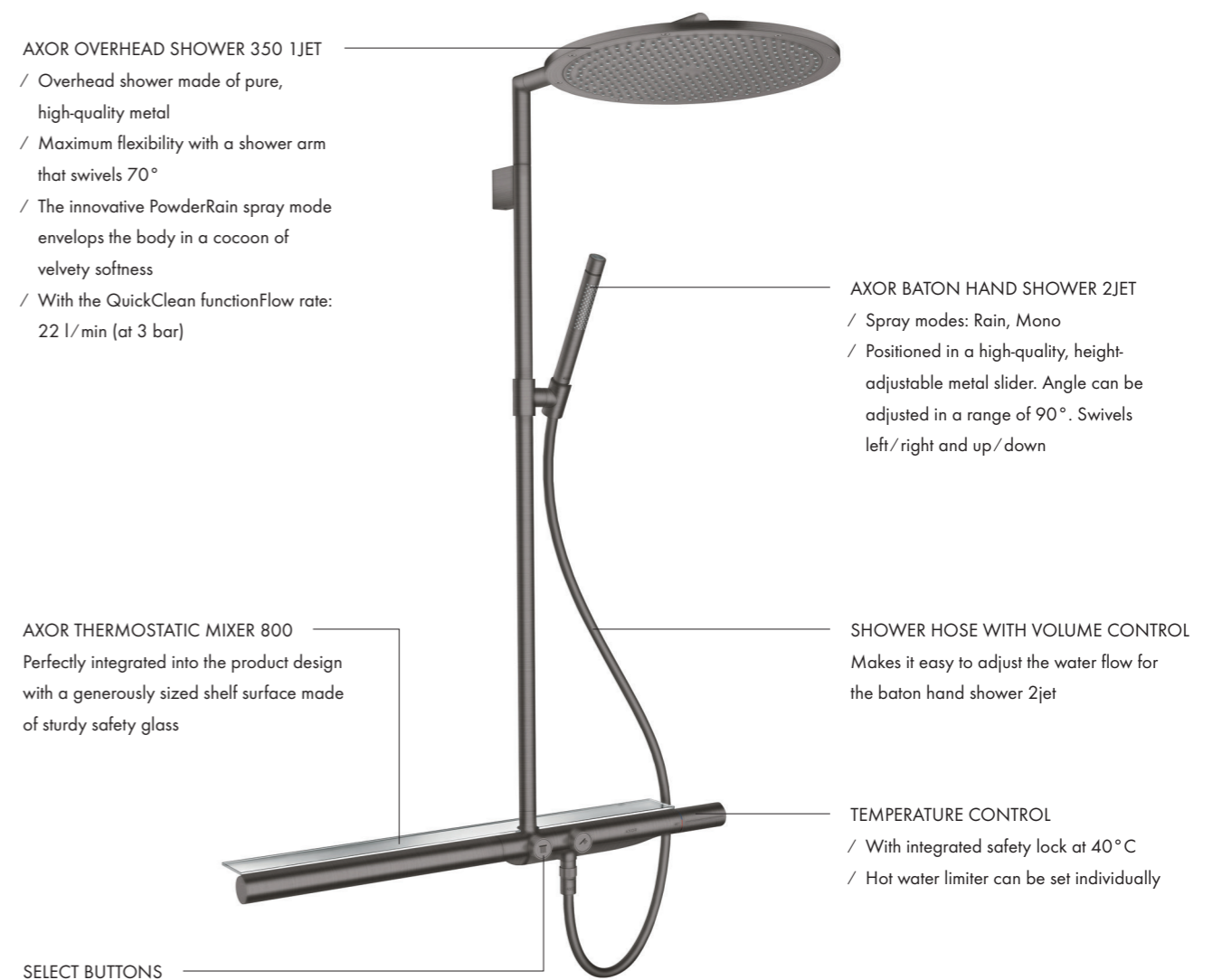

AXOR OVERHEAD SHOWER 350 1JET
/ Overhead shower made of pure, high-quality metal
/ Maximum flexibility with a shower arm that swivels 70°
/ The innovative PowderRain spray mode envelops the body in a cocoon of velvety softness
/ With the QuickClean functionFlow rate: 22 l/min (at 3 bar)

AXOR BATON HAND SHOWER 2JET
/ Spray modes: Rain, Mono
/ Positioned in a high-quality, height-adjustable metal slider. Angle can be adjusted in a range of 90°. Swivels left/right and up/down

AXOR THERMOSTATIC MIXER 800
Perfectly integrated into the product design with a generously sized shelf surface made of sturdy safety glass

SHOWER HOSE WITH VOLUME CONTROL
Makes it easy to adjust the water flow for the baton hand shower 2jet

TEMPERATURE CONTROL
/ With integrated safety lock at 40°C
/ Hot water limiter can be set individually

SELECT BUTTONS
/ For intuitive, user-friendly outlet control with clear function assignment
/ Two outlets (overhead shower and hand shower) can be used simultaneously

Showerpipe with thermostat 800 and overhead shower 350 1jet
27984XXX
27984XXX





The ideal complement. The perfect counterpoint.

AXOR Uno embodies the Purist ethos of simplicity, balance and self-evident function. Consisting of one pipe in a parabolic curve or two fused at a right angle, AXOR Uno mixers approximate the proportions of the golden ratio. The collection offers an ideal complement to modern, minimalist settings, but can also provide the perfect counterpoint to more traditional décor.

Radical simplicity on the outside. Supreme sophistication within.

Deceptively simple in form and function, AXOR Uno features a radically reduced aesthetic that encases state-of-the-art technology for effortless control of water volume and temperature – all at the touch of a button via Select technology, or with a simple push of the intuitive Zero handle. Simpler still, AXOR Uno electronic mixers, mounted on the wall or wash basin, feature infrared sensors that detect when water should flow.



Purist design in the shower for pure shower pleasure.

AXOR Uno offers a wide range of options for the shower, from single-lever mixers, thermostats and diverter valves for concealed installation, to exposed sets with hand showers offering three spray types. Born of similar design principles to those of AXOR Uno and so an ideal companion piece, the AXOR showerpipe 800, includes overhead and baton hand shower, and features a mirrored glass shelf discreetly integrated into its exposed thermostatic mixer.

Available within 2 weeks
AXOR Uno is stocked in 3 finishes

AXOR UNO STOCKED FINISHES
ARE AVAILABLE IN :



AXOR Uno

The power of simplicity

A bathroom collection inspired by the early Modernist aesthetic of Purism, AXOR Uno brings radical simplicity to fixtures for the wash basin, bath and shower. Clean lines, classical geometry and undisguised construction meet precision engineering, innovative technology and options for customisation that Le Corbusier and the Bauhaus could only have dreamed of. The result? A contemporary collection with universal appeal. If less is more, AXOR Uno is most.



SCAN FOR
ARTICLE
NUMBERS





Standing out from the crowd, fulfilling that longing for uniqueness, breaking new ground – AXOR MyEdition stands for all of this.

The clear, straightforward design creates a grand stage for self-realisation and personal creativity. With elegant plates made of the exclusive material of one's choice, AXOR MyEdition represents the avant-garde in the era of customisation.



AXOR MyEdition

THE DEFINITION
OF PERSONAL LUXURY

Unmistakable originals are created.

Each plate is unique in itself, the ultimate luxury at the wash basin and bathtub. Either integrated into the interior design or as a statement in the bathroom.

Consistent design language – for mixer and spray

INDEPENDENT ELEMENTS

The fine line separating body and cover plate has the appearance of a shadow gap. This separation between the independent elements is what makes individualisation possible

INDIVIDUALISATION

The body is the constant element of the mixer and, together with the freedom of choice in selecting monochromatic or combined AXOR FinishPlus PVD surfaces, it forms the basis for maximum individualisation

ERGONOMICS

The M25LS cartridge enables side handle placement for ergonomic use

MATERIALS

The cover plate, a variable element on the mixer, can be individualised as desired.

WATER DESIGN

Multisensory experiences: The velvety soft PowderRain spray mode is the sensory counterpart to the linear design of the mixer. It provides a unique hand-washing experience

MONOLITH

Clear, angular design language; solid form



New spray formers:

The shape of the water spray is derived from the product design. In this case, a rectangular spray former was developed which, in a fixed position, is equipped with PowderRain spray mode as well as QuickClean function for easily removing calcium deposits.



PowderRain spray mode:

AXOR MyEdition is the first collection with the PowderRain spray mode. Satiny smooth droplets emerge from 170 of the finest spray nozzles for a sensual, soft and luxuriant spray experience.



Isolated water conduction:

A separated water conduction is integrated into the metal basic set which separates the conduit from the body so it remains free of lead and nickel concentrations.





A luxury bathroom collection for the age of personalisation.

Opulent or understated? In harmony with the surroundings or in contrast? From the surface finish to the ideal colouring, to the material of the cover plate, the choice belongs to the individual. Combining two exclusive AXOR FinishPlus surfaces, such as the Brushed Black Chrome and Brushed Bronze, can bring an added personal touch. At the wash basin, AXOR MyEdition is available as a single-lever mixer in three different heights, as a wall-mounted mixer and as a classic three-hole mixer.

Setting the stage: A choice of cover plates in luxurious materials.

The AXOR MyEdition mixer body is crowned by a replaceable, rectangular cover plate, available in a choice of finishes and sophisticated materials. Developed with painstaking care, crafted with masterly precision, and tested under extreme conditions, each plate is unique. For those seeking luxury materials not available as standard. The possibilities are practically endless.



Bring the world to your bathroom.

At the bathtub, AXOR MyEdition is available as a minimal wall-mounted tap fitting, as a striking floorstanding mixer, and as a four-hole mixer, shown here with a cover plate in exquisite Nero Marquina marble from the Basque region of Spain.

Available within 2 weeks
AXOR MyEdition is stocked in 4 finishes

AXOR MYEDITION STOCKED FINISHES ARE AVAILABLE IN :

BRUSHED BLACK
CHROME
- 340

BRUSHED
BRONZE
- 140



MATT
BLACK
- 670

CHROME
- 000

AXOR MyEdition

A personal statement

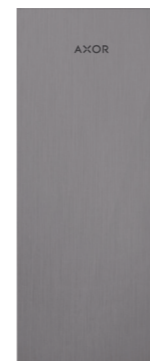
With its monolithic, linear design, AXOR MyEdition provides you with a stage for self-expression. A wide selection of cover plates made of exclusive materials leaves room for your own creativity. The collection responds to a human desire to have something unique, to stand out from the crowd and to move in new directions.



SCAN FOR
ARTICLE
NUMBERS



The Tradition of

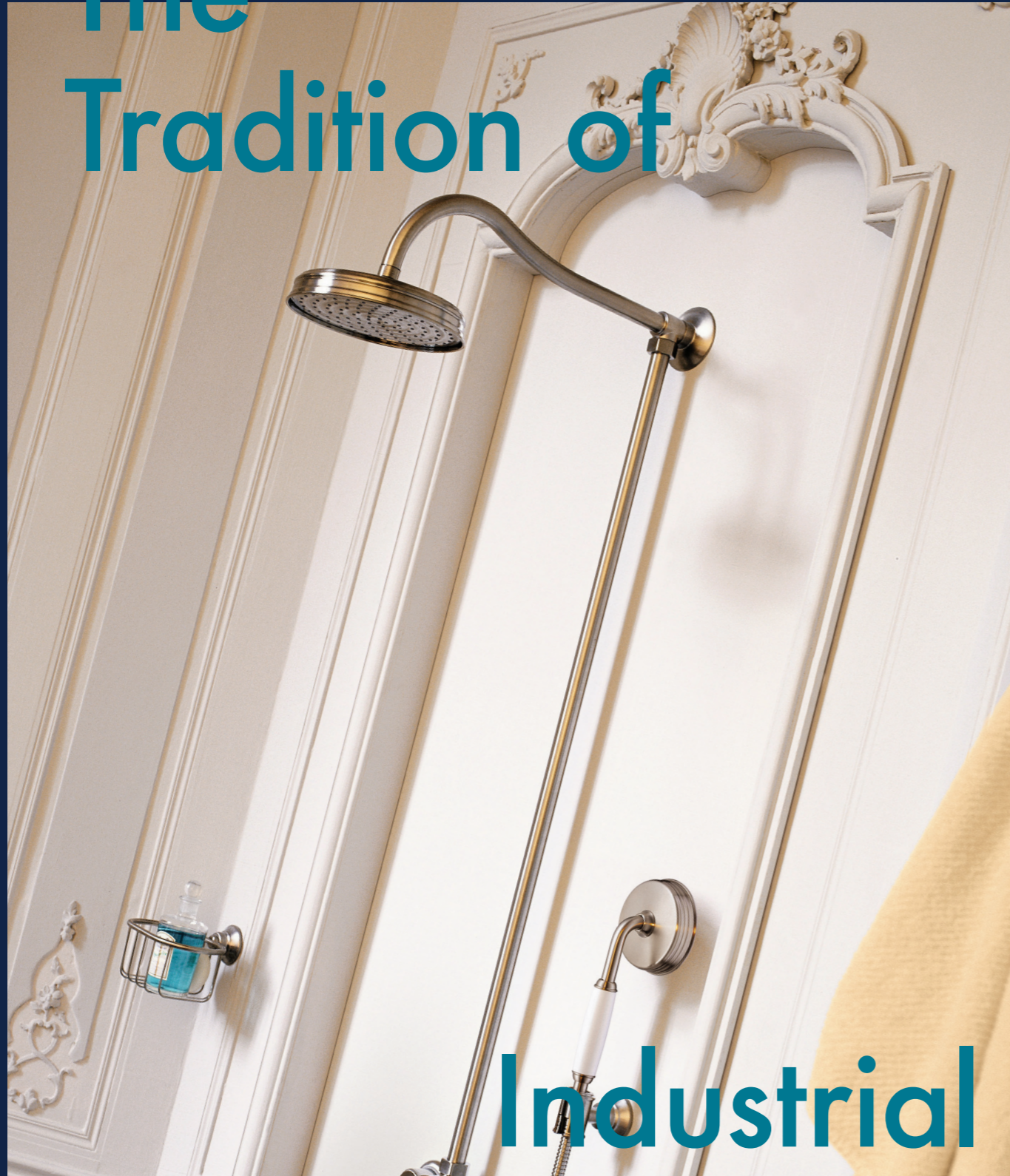

Industrial Design

The Belle Époque, at the turn of the 19th and 20th centuries, was an age of awakening and technological progress. Immortalised in the grand hotels of Europe and particularly in Montreux, the legendary spa town on Lake Geneva. The AXOR Montreux collection, inspired by this tradition and history, captures the authentic design of the first industrially manufactured mixers.

AXOR Montreux

DESIGN
—
PHOENIX



Additive design in the tradition of the industrial age

AXOR Montreux pays homage to the Belle Époque. Along with wash basin mixers, it offers products for every bathroom area. The collection includes classic versions with low spouts and modern reinterpretations with high spouts. Choose from cross handles or lever handles.



Modern functionality – authentic in design

Authentic showering. The AXOR Montreux Showerpipe. Externally: Belle Époque. Internally: State-of-the-art. With cutting-edge thermostat technology. And clearly separate control units for overhead and hand showers. Committed to technological advancement. Just like the era of the Belle Époque.

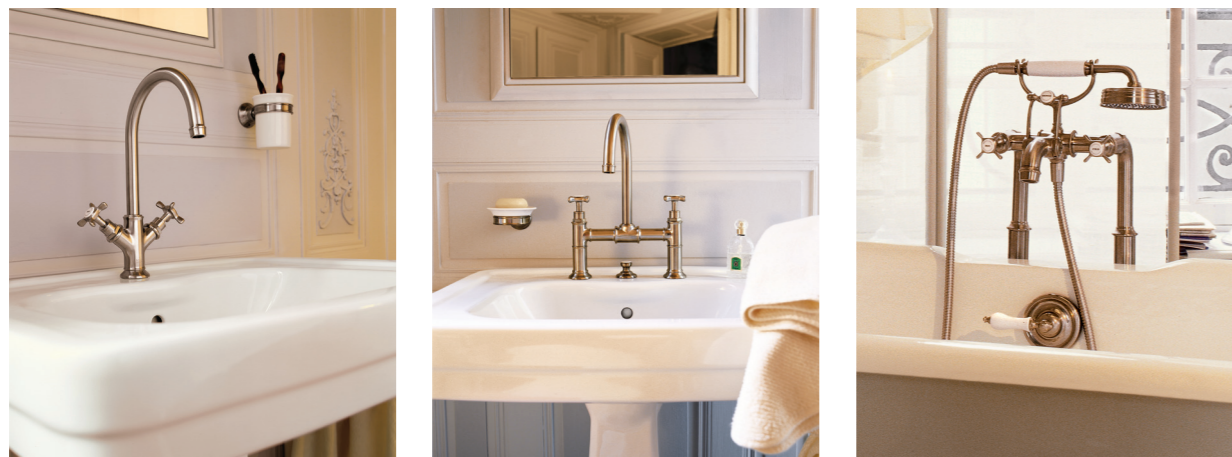
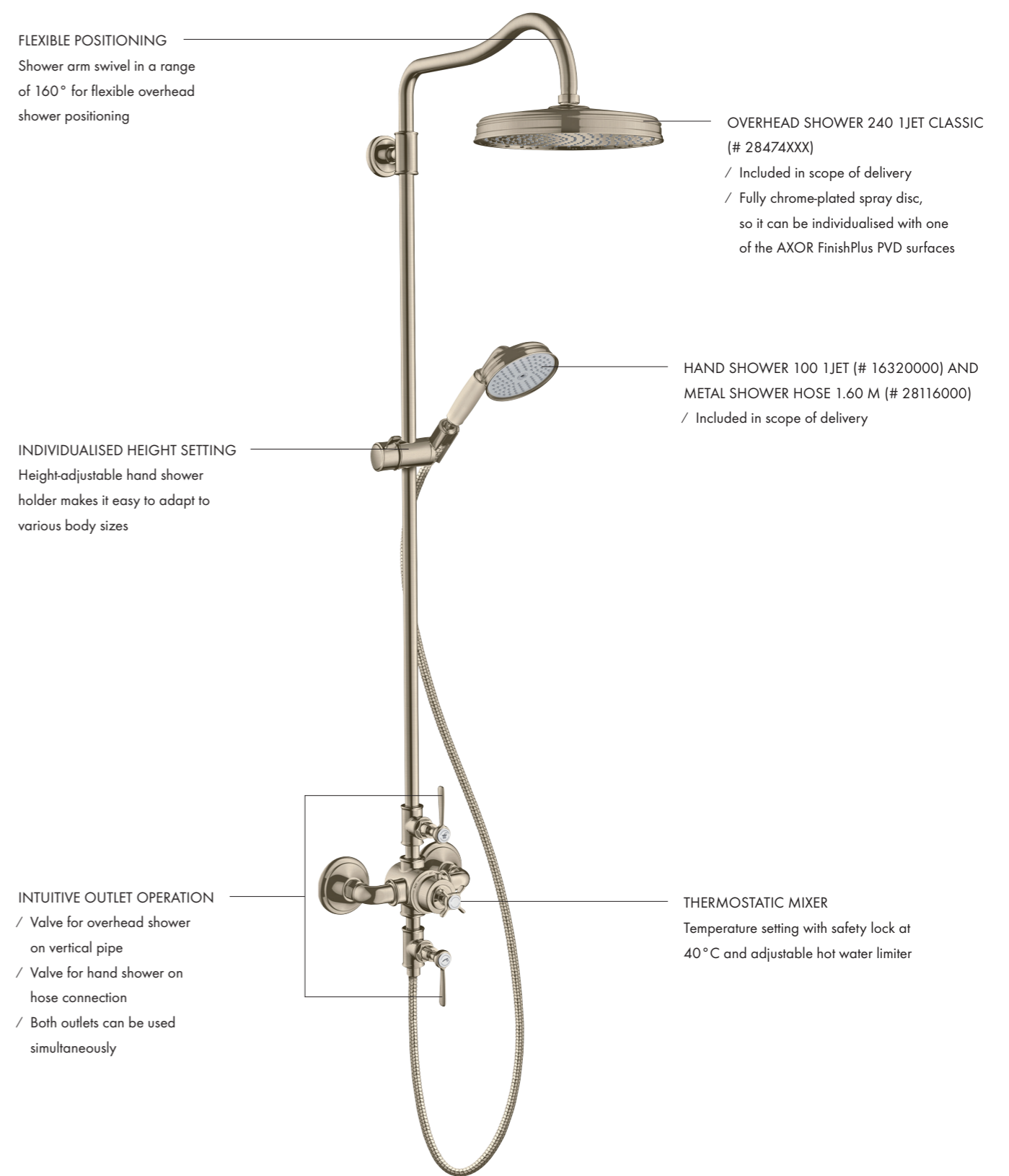



Classic yet modern: The union of craftsmanship and technology.

Traditional industrial design meets state-of-the-art technology and manufacture in AXOR Montreux. For an authentic Belle Époque look, the collection includes low-spout mixers, bridge mixers and classic cross handles with porcelain inlays. High-spout mixers, three-hole mixers and lever handles offer a modern interpretation of the style. At the wash basin, four mixers, including a wall-mounted version, are available. For the bath, AXOR Montreux mixers range from floorstanding to four-hole tile-mounted to exposed-installation two-handle wall-mounted, all with a choice of cross or lever handles.

In the shower, modern technology concealed in classic design.

In the shower, AXOR Montreux offers thermostatic mixers for concealed installation as well as showerpipes with exposed thermostats. Distinctive control units enable effortless operability of both overhead and hand showers, some with soothing RainAir Spray. Details such as the configuration of nozzles on the hand showerhead, together with the grooved cable and porcelain inlay on the handle, encapsulate the timeless appeal of early luxury bathroom design.

Porcelain inlays with authentic lettering.

Crafted with painstaking attention to detail, classic porcelain inlays with authentic lettering pay tribute to early modern industrial design. For a discreet, personal touch, these plates can be monogrammed with initials or a logo, emblem or insignia, a service provided by AXOR Signature. The entire AXOR Montreux collection can be further personalised by one of up to 15 exclusive AXOR FinishPlus surfaces.



Available within 2 weeks
AXOR Montreux is stocked in 3 finishes

AXOR MONTREUX STOCKED FINISHES
ARE AVAILABLE IN :

BRUSHED BLACK
CHROME
- 340

BRUSHED
NICKEL
- 820

CHROME
- 000

AXOR Montreux

The tradition of industrial design

The AXOR Montreux mixer collection is modelled on the first industrially produced mixers from around the turn of the last century.

The Belle Époque era symbolizes a time of fundamental change and technical progress. Immortalised in Europe's grand hotels and in Montreux, the legendary spa resort on the shores of Lake Geneva.

AXOR Montreux combines outstanding technology with modern functionality.



SCAN FOR
ARTICLE
NUMBERS



Innovation meets design



Showering becomes an experience



AXOR ShowerComposition

DESIGN
—
PHILIPPE STARCK



Reflecting uniqueness – making an architectural statement.

AXOR ShowerComposition features a reduced, rectilinear design, the diminutive depth of the showerhead and vertical panels, which extend just 10mm from the wall, counter balanced by their generous width. While the easy-to-install shower panel offers full functionality in one single basic set, individual shower modules can be composed and arranged for a truly personalised shower experience.

Innovation meets design. Showering becomes an experience.

Versatile and easy to install, the AXOR ShowerComposition program is available in a variety of configurations. The all-in-one shower panel integrates an overhead shower, a body shower, a thermostatic module and a hand shower as well as a textile-wrapped shower hose.

AXOR ShowerComposition is also available as a shower module with a 1-jet overhead shower, a shower module with a 1-jet overhead and a shoulder shower, or a shower module with a 2-jet overhead and a shoulder shower. A separate 1-jet adjustable shoulder shower module offers additional flexibility.

The dimensions of the AXOR ShowerComposition showers match perfectly with those of the AXOR Universal Rectangular Accessories, ensuring a cohesive design language throughout the shower area.



Available within 2 weeks
AXOR ShowerComposition is stocked in 2 finishes

AXOR SHOWERCOMPOSITION
STOCKED FINISH IS AVAILABLE IN :



MATT
BLACK
- 670



CHROME
- 000

AXOR ShowerComposition

AXOR ShowerComposition introduces a striking new universal design language, modern and timeless, to the shower area. The program features sleek, flat surfaces and ultra-slim profiles in an architectonic composition that presents novel possibilities for individual expression. Whether as an all-in-one shower panel or a personalised arrangement of floating modules, AXOR ShowerComposition offers exceptional performance, including immersive PowderRain spray mode overhead and PowderRain shoulder showers with angle adjustment. AXOR ShowerComposition provides the maximum of services by using the minimum of matter.



Available from October 2023

SCAN FOR
ARTICLE
NUMBERS





Wellness. Elegance.
Luxury.

AXOR Showers

DESIGN
—
PHILIPPE STARCK
PHOENIX
NENDO
FRONT
BARBER OSGERBY

Ultimate in design, impressive in space:
AXOR shower products offer a captivating experience that
celebrates the precious element of water.
Perfect design objects for the body, the mind, and the room,
making the shower a safe haven.

Intuitive control in the shower

Uncompromising in its purist form, the thermostatic mixer 800 for exposed/concealed installation unites the advantages of both types of installation. Exposed in that the thermostatic mixer provides a large mirror glass shelf. Concealed because the pipework is behind the wall. Thanks to Select technology, which makes the thermostatic mixer control intuitive.



Thermostatic module Select 600/90 for concealed installation for 4 functions

Basic set
18312180



Thermostatic module Select 530/90 for concealed installation for 3 functions

Basic set
18311180



Thermostatic module Select 460/90 for concealed installation for 2 functions

Basic set
18310180

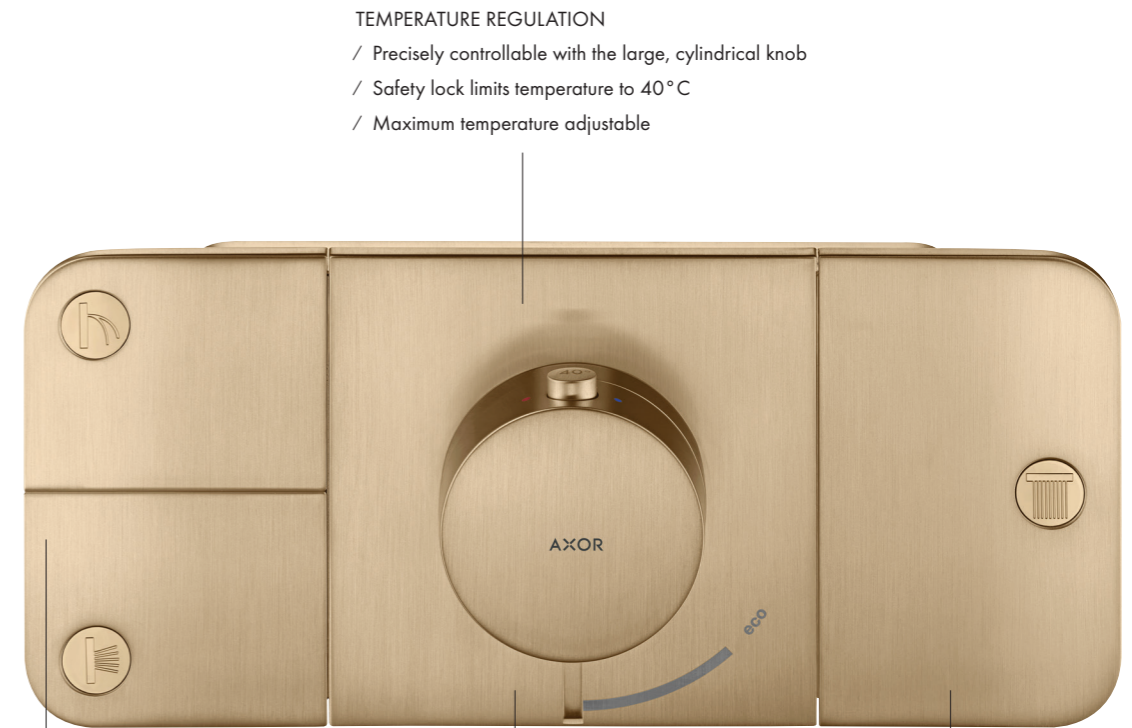
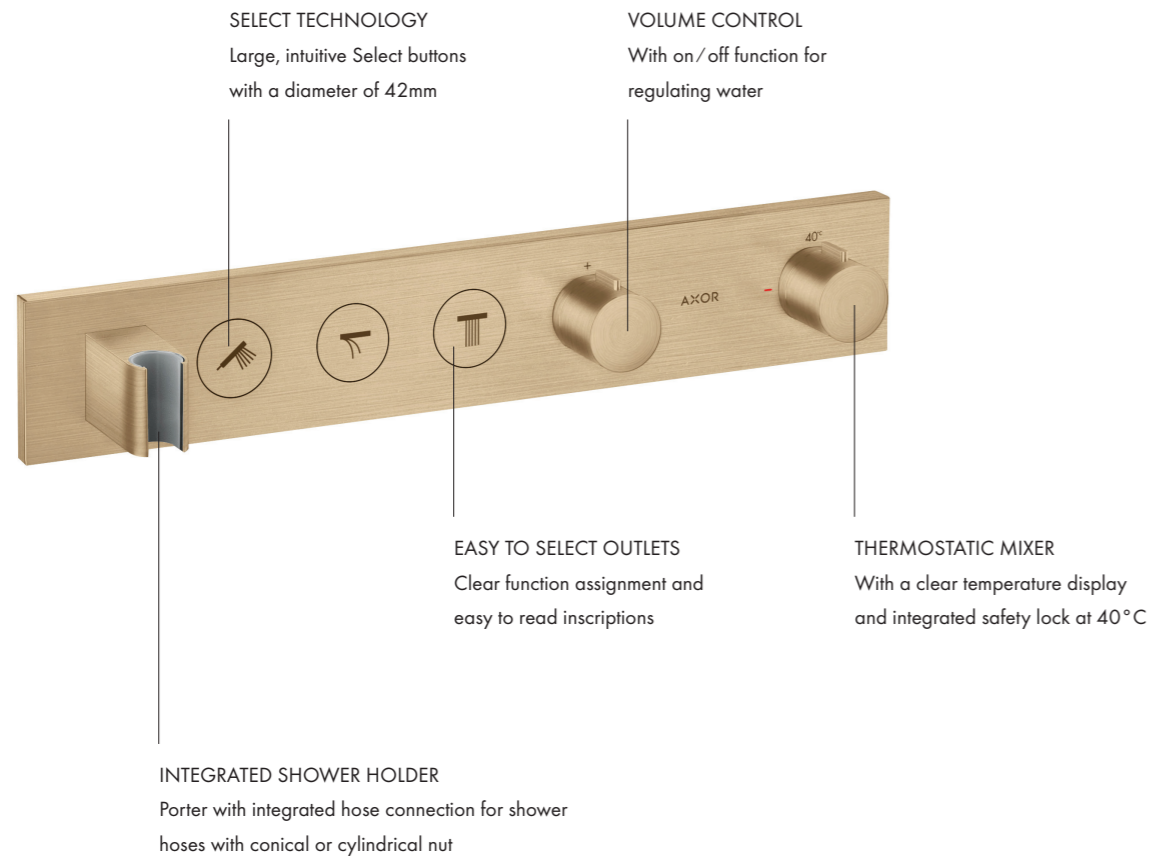

Thermostatic module for concealed installation for 3 functions

Basic set
45710180



Thermostatic module for concealed installation for 2 functions

Basic set
45710180



Thermostatic module for concealed installation for 1 function

Basic set
45710180



Shut-off valve for concealed installation

Basic set
45770180

SCAN FOR ARTICLE NUMBERS



Overhead showers

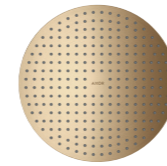

Overhead shower 300 2jet ceiling-exposed



1jet ceiling-exposed (not shown)



Basic set for overhead shower ceiling-exposed # 35363180

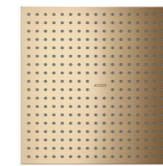

Overhead shower 300/300 2jet ceiling-exposed



1jet ceiling-exposed (not shown)



Basic set for overhead shower ceiling-exposed # 35363180



Overhead shower 350 1jet with shower arm

with ceiling connection (not shown)



/ Optional part:
Extension set 230mm for ceiling connector (# 13603, -000, -xxx)
/ Due to technical reasons this product is not available in Polished and Brushed Black Chrome

/ Optional accessories: Softsquare escutcheon # 35214XXX



Overhead shower 300 2jet with shower arm



Basic set 2jet # 35361180

1jet with shower arm (not shown)



Overhead shower 300/300 2jet with shower arm



Basic set 2jet # 35361180

1jet with shower arm (not shown)



Overhead shower 300 2jet with ceiling connection



1jet with ceiling connection (not shown)



Basic set for overhead shower with ceiling connector # 26434180



Overhead shower 300/300 2jet with ceiling connection



1jet with ceiling connection (not shown)



Basic set for overhead shower with ceiling connector # 26434180

/ Optional accessories: Softsquare escutcheon # 35214XXX

SCAN FOR ARTICLE NUMBERS



Overhead showers



Overhead shower 280 2jet with ceiling connection

Basic set
26434180



Overhead shower 280 1jet with ceiling connection



Plate overhead shower 240 1jet



Overhead shower 180 1jet



Can be combined with:

Ceiling connector 300mm round (# 26433XXX), square (# 26438XXX), softsquare (# 26966XXX), Ceiling connector 100mm round (# 26432XXX), square (# 26437XXX), softsquare (# 26965XXX), Shower arm 390mm round (# 26431XXX), square (# 26436XXX), softsquare (# 26967XXX)

/ Connection thread G 1/2



Overhead shower 245/185 1jet 12 l/min

Ecosmart 9 l/min

Ecosmart+ 6 l/min



Overhead shower 220 1jet 12 l/min

Ecosmart 9 l/min

Ecosmart+ 6 l/min



Overhead shower 245 1jet 12 l/min

Ecosmart 9 l/min

Ecosmart+ 6 l/min



Can be combined with:

Ceiling connector 300 mm round (# 26433XXX) square (# 26438XXX) softsquare (# 26966XXX) Ceiling connector 100 mm round (# 26432XXX) square (# 26437XXX) softsquare (# 26965XXX) Shower arm 390 mm round (# 26431XXX) square (# 26436XXX) softsquare (# 26967XXX)



Ceiling connector 300 mm for overhead shower 280 2jet



Ceiling connector 300 mm for overhead shower 280 1jet



Shower arm 390 mm softsquare



Wall plate 120/120 softsquare

Goes well with:

300 2jet overhead shower (# 35303XXX), 300 1jet overhead shower (# 35300XXX), 250 2jet overhead shower (# 35296XXX), 250 1jet overhead shower (# 35284XXX), 300/300 2jet overhead shower (# 35318XXX), 300/300 1jet overhead shower (# 35314XXX), 250/250 2jet overhead shower (# 35310XXX), 250/250 1jet overhead shower (# 35306XXX)

Combinable with:

/ Shower arm 389 mm (# 27348, -000, -xxx)

Showers



Wall outlet softsquare

Wall outlet square (not shown)



Wall outlet round



Shower holder

/ For shower hoses with conical nuts on both sides



Metal effect shower hose 1.25m

Metal effect shower hose 1.60m (not shown)

Metal effect shower hose 2.00m (not shown)



Porter unit 120/120 with baton hand shower 2jet and shower hose



Porter unit round

Porter unit square (not shown)

/ Cylindrical nuts on both sides

Thermostats



Thermostat for concealed installation soft-square for 2 functions

Basic set iBox universal
01700180



Thermostat for concealed installation round for 2 functions

Basic set iBox universal
01700180



Thermostat for concealed installation square for 2 functions

Basic set iBox universal
01700180



SCAN FOR ARTICLE NUMBERS





AXOR ShowerCollection: A tailored shower experience.

Designed by Philippe Starck, the modular AXOR ShowerCollection brings a made-to-measure experience to the shower. Select from an array of elements, including overhead showers, body jets, hand showers, thermostatic mixers and shelves. Easy to install, elements may be arranged horizontally or vertically, freely or in groups.



AXOR overhead showers. Freedom of choice.

AXOR overhead showers are the perfect complement to any AXOR collection. Available in circular or square designs and a variety of sizes, they feature an outstanding innovation on the shower plate: nozzles that retract when water is turned off. The result? A smooth and immaculate surface, in harmony with the overall design.

AXOR ShowerSelect. Hidden technology, visible convenience.

AXOR ShowerSelect thermostatic mixers offer effortless, intuitive operability. Select technology enables temperature pre-selection and a choice of spray modes at the touch of a button. The mixers are available in Soft Cube, square or round variants. With their ultra-slim design, AXOR ShowerSelect thermostatic mixers are the ideal complement to AXOR's wide range of overhead showers.

Design: PHOENIX



Available within 2 weeks
AXOR Showers is stocked in 7 finishes

AXOR SHOWER SOLUTIONS STOCKED FINISHES ARE AVAILABLE IN :



AXOR SHOWER PRODUCTS REPRESENT DESIGN, INNOVATION AND WATER EXPERIENCES AT THE HIGHEST LEVEL.

AXOR Showers

Excellence in the shower

Flawless design. Intuitive function. Unrivaled innovation. All contribute to a shower experience like no other. The AXOR shower experience.

In styles that harmonise with every decor, the AXOR shower range comprises overhead showers, body jets, hand showers, modular shower systems, showerpipes, thermostatic mixers and state-of-the-art control units with Select technology.

Design: Philippe Starck, Nendo, Front, Barber Osgerby, PHOENIX

CHARACTERISTIC DESIGN FEATURE:
Avant-garde design objects with universal appeal – for combinations across different collections.

THE DESIGNERS' IDEA:
Luxury in the shower: AXOR Showers offer fascinating design, perfect function and a one-of-a-kind water experience. The user is the focus of the luxurious physical experience provided by an AXOR Shower.

- SPECIAL PROGRAM HIGHLIGHTS:
- / AXOR ShowerCollection: A modular system consisting of overhead showers, shower modules, thermostatic mixers, valves and shelves
 - / AXOR Showerpipe designed by Front: An object in authentic industrial design language
 - / AXOR One thermostatic mixers: Innovative control and easy to use thanks to Select technology
 - / Wide variety of spray modes for various applications: From invigorating to massaging to softly enveloping

Timeless,
universal,



elegant
forms.

A personal touch in the bathroom

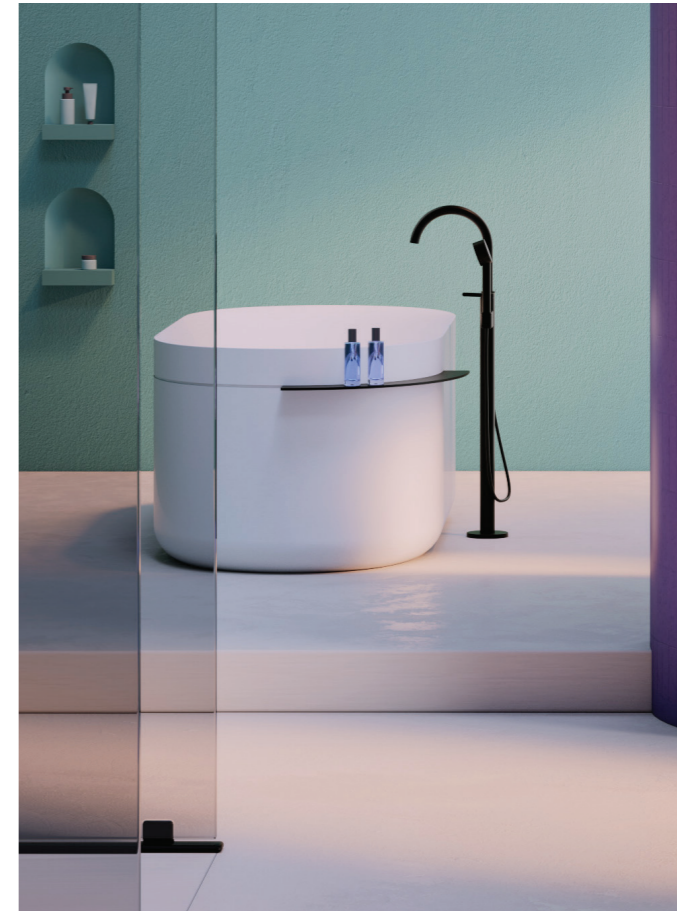

AXOR Suite
Basins & Bathtub

DESIGN
-
PHILIPPE STARCK



Uniquely Universal - matching your character.

Rectangular or circular, the AXOR Suite basins are timeless, universal, elegant forms, characterised by small radii, soft and smooth inner basins. They are encased in Matt Black, Chrome or one of the polished or brushed AXOR FinishPlus finishes, creating another luxurious option for a personal touch in the bathroom.

Bring harmony and a personal touch to any bathroom interior.

"The new AXOR Suite washbasin combines metal and SolidSurface - a highly technological material - symbolising eternity and elegance", says Philippe Starck.



Available within 2 weeks
AXOR Suite Basins & Bathtub are stocked in 4 finishes

AXOR SUITE BASINS AND
BATHTUB STOCKED
FINISHES ARE AVAILABLE IN :



MATT
BLACK
- 670



BRUSHED
BRONZE
- 140



BRUSHED BLACK
CHROME
- 340



CHROME
- 000



AXOR Suite Basins & Bathtub

Through elegant design and specially finished elements, AXOR Suite basins and bathtub, designed by world-renowned creator Philippe Starck, bring harmony and a personal touch to any bathroom interior. Each piece is made with SolidSurface material for resistance and longevity, while smooth contours, small radii and 'soft' inner basins, devoid of lines or ridges, ensure a clean modern look with universal appeal. At the same time, specially finished elements - a shelf on the bathtub, a wrap-around surface on the washbasin sides - allow users to express their individuality.



Available from October 2023

SCAN FOR
ARTICLE
NUMBERS



A synthesis.
An evolution.



A continual
sophistication.

The essence of elegance.



AXOR Drain



AXOR Drain makes an individual statement grounded in excellent function.

The new AXOR Drain features a long, minimalist exposed rectangular design cover, available in all AXOR FinishPlus PVD surfaces.



Shower drains become a design object.

With no visible connecting silicone joints, the AXOR Drain melds seamlessly with the surrounding materials and can be easily removed with the included grate lifter. The finish set comes in two installation versions, in-floor and wall-mounted, and five sizes, ensuring a precise, personalised fit. A removable inlay serves as an installation aid, allowing tiles to be positioned perfectly before inserting the actual finish set. For drainage solutions, users can choose between the pre-installed standard Siphon, or substitute it for the included Dryphon, which contains a self-opening, silicone membrane. Dryphon technology allows for a high flow rate of up to 55 litres/min, preventing buildup and thus reducing cleaning to a minimum. AXOR Drain also utilises the uBox – a height-adjustable, leak-tight drainage basic set designed for all AXOR products, available in three variants to meet all country standards.

Available within 2 weeks
AXOR Drain are stocked in 7 finishes

AXOR DRAIN STOCKED FINISHES ARE AVAILABLE IN :

- 
BRUSHED BLACK CHROME
 - 340
- 
CHROME
 - 000
- 
BRUSHED BRONZE
 - 140
- 
POLISHED GOLD OPTIC
 - 990
- 
MATT BLACK
 - 670
- 
MATT WHITE
 - 700
- 
BRUSHED STAINLESS STEEL OPTIC
 - 800

AXOR Drain

AXOR Drain elevates the shower drain to an object of design that completes the look of any AXOR bathroom. The first design in the program offers a sleek and seamless aesthetic, without visible silicone joints, harmonising with various shower floor surfaces – from marble to porcelain, travertine to slate. Thanks to newly acquired innovative technology and outstanding AXOR quality, the drains are easy to install, require minimum cleaning and offer uncomplicated access to one's choice of Siphon or Dryphon draining mechanism.



SCAN FOR ARTICLE NUMBERS





Perfection in
Every Detail

EACH INDIVIDUAL
AXOR ACCESSORY IS, IN
ITSELF, A ONE-OF-A-KIND
DESIGN OBJECT.

AXOR Accessories

Highest expression of individual style

Even the smallest details can say something about our personality. For individualists, accessories are no minor matter. They are that certain something. They are a statement with a message. AXOR accessories reflect the aspiration of individual design and holistic excellence that underlies the entire AXOR product range.

Design: Philippe Starck, Antonio Citterio, Barber Osgerby,
PHOENIX

CHARACTERISTIC DESIGN FEATURE:

From minimalist to sculptural, from organic to classic, from extravagant to universal.

THE DESIGNERS' IDEA:

Perfect accessories: AXOR Accessories are coordinated with the various collections so that they complement and complete the bathroom atmosphere. Or bring the extra flair of a design object to the bathroom or kitchen. In contrast, AXOR Universal Accessories are linear and modular in design, so they complement many different collections.

SPECIAL PROGRAM HIGHLIGHTS:

- / AXOR Universal Rectangular Accessories: ideal complement to AXOR collections with cubic or rectangular design language
- / AXOR Universal Circular accessories: Timeless, round design, versatile combinations
- / AXOR Universal Softsquare Accessories: Modular, versatile range in linear design
- / AXOR Montreux: Authentic-traditional design, for combination with classic mixers and shower products



Available within 2 weeks
 AXOR Universal Rectangular is stocked in 7 finishes

AXOR UNIVERSAL RECTANGULAR
 ACCESSORIES STOCKED
 FINISHES ARE AVAILABLE IN :

- | | |
|---|--|
| 
BRUSHED BLACK
CHROME
- 340 | 
POLISHED
GOLD OPTIC
- 990 |
| 
BRUSHED
BRONZE
- 140 | 
BRUSHED
NICKEL
- 820 |
| 
MATT
BLACK
- 670 | 
MATT
WHITE
- 700 |
| 
CHROME
- 000 | |

AXOR Universal Rectangular Accessories

The new AXOR Universal Rectangular Accessories, developed in collaboration with Philippe Starck, are the ideal complement to any AXOR collection with a cubic or rectangular design language. Their clear, no-frills design never takes center stage, but sets understated, high-quality accents in the bathroom. The broad product range includes a shaving mirror, a soap dispenser, toilet paper holders, and a variety of towel bars.

Design: Philippe Starck



SCAN FOR
 ARTICLE
 NUMBERS



Available within 2 weeks
 AXOR Universal Circular is stocked in 7 finishes

AXOR UNIVERSAL CIRCULAR
 ACCESSORIES STOCKED
 FINISHES ARE AVAILABLE IN :

- | | |
|---|--|
|  |  |
| BRUSHED BLACK
CHROME
- 340 | POLISHED
GOLD OPTIC
- 990 |
|  |  |
| BRUSHED
BRONZE
- 140 | BRUSHED
NICKEL
- 820 |
|  |  |
| MATT
BLACK
- 670 | MATT
WHITE
- 700 |
| |  |
| | CHROME
- 000 |

AXOR Universal Circular Accessories

With their minimalist, delicate, and timeless design combined with the utmost precision, AXOR Universal Circular accessories offer simplicity in form – for a harmonious overall impression in the bathroom. The products are characterised by a consistent, recognisable design language that runs through all areas of the bathroom – with slim silhouettes, rounded corners, and balanced proportions. Thanks to their timeless design, the products can be combined completely freely with different styles and fit perfectly with the AXOR portfolio collections. AXOR FinishPlus allows for customisation with different PVD surfaces, as well as the new lacquered Matt Black surface.

Design: Barber Osgerby



SCAN FOR
 ARTICLE
 NUMBERS



Available within 2 weeks
 AXOR Universal Softsquare is stocked in 7 finishes

AXOR UNIVERSAL SOFTSQUARE
 ACCESSORIES STOCKED
 FINISHES ARE AVAILABLE IN :

- 

**BRUSHED BLACK
 CHROME**
 - 340
- 

**POLISHED
 GOLD OPTIC**
 - 990
- 

**BRUSHED
 BRONZE**
 - 140
- 

**BRUSHED
 NICKEL**
 - 820
- 

**MATT
 BLACK**
 - 670
- 

**MATT
 WHITE**
 - 700
- 

CHROME
 - 000

AXOR Universal Softsquare Accessories

A new take on the special in everyday life: The AXOR Universal Softsquare accessories – including shelves, bath towel bars, soap dispensers, and even coat hooks – are timelessly elegant extras that can be used individually or flexibly combined with each other. With their straightforward, generic design, they complete the overall aesthetic impression of an individual bathroom or kitchen design. Their elegantly rounded corners and universal design harmonise with several AXOR collections and very different style worlds.

Design: Antonio Citterio



SCAN FOR
 ARTICLE
 NUMBERS



Available within 2 weeks
 AXOR Montreux Accessories is stocked in 3 finishes

AXOR MONTREUX ACCESSORIES
 STOCKED FINISHES ARE
 AVAILABLE IN :

 BRUSHED BLACK
 CHROME
 - 340

 BRUSHED
 NICKEL
 - 820

 CHROME
 - 000

AXOR Montreux Accessories

AXOR Montreux brings Belle Époque elegance and charm to the bathroom. Complete the classic look with a wide range of accessories, from soap basket to towel rail, shaving mirror to toothbrush tumbler. Like the mixers and showers of the collection, each accessory is an authentic luxury design object, inspired by the bathroom fittings of the early industrial age and manufactured to the highest standards of quality.

Design: PHOENIX



SCAN FOR
 ARTICLE
 NUMBERS





DESIGN
—
PHILIPPE STARCK
ANTONIO CITTERIO
PHOENIX

AXOR PRESENTS

Culinary Evolution

Kitchen mixers from AXOR. Created for avant-garde design in the kitchen. A place where evolutions of the highest culinary standard are created. Where new dimensions in sensuality and aesthetics are created. AXOR kitchen mixers bear the hallmarks of the world's best designers. With the innovative capacity of AXOR. Such as the Select operating technology. An example of the latest technological advances. Excellence in the kitchen. Perfection.

Available within 2 weeks
AXOR Kitchen is stocked in 4 finishes

AXOR KITCHEN MIXERS STOCKED
FINISHES ARE AVAILABLE IN :



MATT
BLACK
- 670



CHROME
- 000



BRUSHED BLACK
CHROME
- 340



BRUSHED
STAINLESS
STEEL OPTIC
- 800

AXOR Kitchen Mixers

AXOR kitchen mixers combine striking beauty with intuitive technology, masterful design with precision engineering. Ensuring effortless ease of operation for all who appreciate the art of cooking, from amateur gastronomes to professional chefs de cuisine, they can also inspire culinary evolution.

Opening new aesthetic vistas in the kitchen, the mixers are offered in Stainless Steel-Optic, Brushed Black Chrome and Matt Black.

Design: Philippe Starck, Antonio Citterio, PHOENIX



SCAN FOR
ARTICLE
NUMBERS



AXOR BASIC SETS, WASTE SETS
AND OVERFLOW SETS STOCKED
FINISHES ARE AVAILABLE IN :

- | | |
|---|---|
|  |  |
| BRUSHED BLACK
CHROME
- 340 | POLISHED
GOLD OPTIC
- 990 |
|  |  |
| BRUSHED
BRONZE
- 140 | BRUSHED
NICKLE
- 820 |
|  |  |
| MATT
BLACK
- 670 | CHROME
- 000 |

AXOR Basic Sets, Waste Sets and Overflow Sets

Technology with a system

The perfection of AXOR continues into the wall and below the bathtub or wash basin, always making an appearance where mixers and showers are installed. The AXOR basic sets, waste sets and overflow sets are based on the many years of expertise gathered by the Hansgrohe Group. They are produced according to the highest quality standards.

Technology with a system

Fillers, waste sets and overflow sets for bathtubs



Complete set bath filler, waste and overflow set for standard bath tubs



Complete set bath filler, waste and overflow set for special bath tubs



Finish set bath filler, waste and overflow set



Finish set waste and overflow set

Waste- and overflow set for bath tubs



Complete set waste and overflow set for standard bath tubs



Complete set waste and overflow set for special bath tubs

Waste sets for wash basins / Bidet



Waste set push-open for basin and bidet mixers



Waste set non-closing for washbasins

Siphons



Design trap Flowstar S



Cover



Angle valve with cover outlet G 3/8

Kitchen



Kitchen device shut-off valve

SCAN FOR
ARTICLE
NUMBERS



HEADQUARTERS

AXOR/Hansgrohe SE/AustraÙe 5-9/77761 Schiltach
Tel. +49 7836 51-0/Fax +49 7836 51-1300/info@axor-design.com/axor-design.com

UNITED KINGDOM

Hansgrohe Limited/Unit 2/Edgehill Drive/Tournament Fields/Warwick/CV34 6XQ
Tel. 01926 242300/customerservices@hansgrohe.co.uk/pro.hansgrohe.co.uk

Hansgrohe Limited
Unit 2, Edgehill Drive
Tournament Fields
Warwick CV34 6XQ
info@axor-design.com

AXOR-DESIGN.COM



AXOR Stocked Profiles Brochure 2023
Form No 07004565